







MANISCOPIC

MANITOU
SCANTRUCK

MLT627 TURBO
COMPACT
SCANTRUCK

2R
SCHÖBLING
Spezial für die Umwelt



Control panel with buttons:

- Green button with 'H' symbol
- Green button with a square icon
- Green button with a square icon
- Yellow button with a gear icon

Control panel with buttons:

- Yellow button with 'L' symbol
- Black button
- Black button
- Black button

Important! Daily check!
Engine oil level Check for oil leak!
Water level (cooling system) Check for air filter!
Oil level in hydraulic tank! Clean cooler!

SCANIA
SCANIA TRUCKS
SCANIA TRUCKS
SCANIA TRUCKS

SCANIA
SCANIA TRUCKS
SCANIA TRUCKS
SCANIA TRUCKS

MANISCOPIC

MLT 627

TURBO "COMPACT"
Evolution



- Maximum lifting height : 5.50 m
- Capacity : 2700 kg
- Maximum forward reach : 3.20 m
- Torque convertor
- JSM : an «all in one» system

1) *Hydraulic controls*

2) *Forward/Reverse selection*

Forward/reverse
shift

Lowering

Tipping

Tilting

Lifting

Roller

for the attachment function
(movement 100 % proportional)

Roller for
extending-retracting the boom
(100 % proportional movements)

STANDARD OR
LOW PROFILE CAB
VERSIONS AVAILABLE

 **MANITOU**

MLT 627 20" TURBO

 **Lifting capacity**2700 kg
at 500 mm from forks heels.

 **Lifting height**5.50 m
Times : unladen/loaded (in s)
Lifting6.65/7.02
Lowering4.88/4.87
Boom extension4.8/4.85
Boom retraction3.02/3.34
Time unladen (in s)
Crowd3.16
Dump2.99

 **Tyres**
400/70-20 T37

 **Forks** (mm)
Length1200
Width125
Carriage rotation154°

 **Oil bath multidisc brakes on front/rear axle**

 **Perkins engine STAGE III A**
Type1104 D 44 T
Cylinders4 cyl./4400 cm³
Power (ISO/TR 14396)101 HP/74.5 kw
Maximum torque392 Nm at 1400 tr/mn
Direct injection
Water cooling

 **Transmission**Torque Convertor
Electro - hydraulic reversing shift
4 speeds forward and reverse
Maximum travel speed30 km/h

 **Hydraulics**
Lifting/tilting pump :
gear type105 l./mn - 250 bars
Monolever **J.S.M (Joystick Switch and Move)**
Flow divider with priority to steering

 **Capacities**
Cooling system25 l.
Engine oil8.5 l.
Hydraulic oil98 l.
Transmission oil14.5 l.
Fuel tank104 l.

 **Weight unladen** (with forks) :5935 kg
Overall width2.01 m
Overall height
MLT 627 T compact2.06 m
MLT 627 T2.21 m
Turning radius (outside wheels)3.70 m
Overall length4.69 m
Ground clearance0.36 m
Drawbar pull :
MLT 627 T/MLT 627 T compact7100 daN

"TAILOR MADE" DIMENSIONS

Overall width : 2.01 m
Overall length : 4.69 m

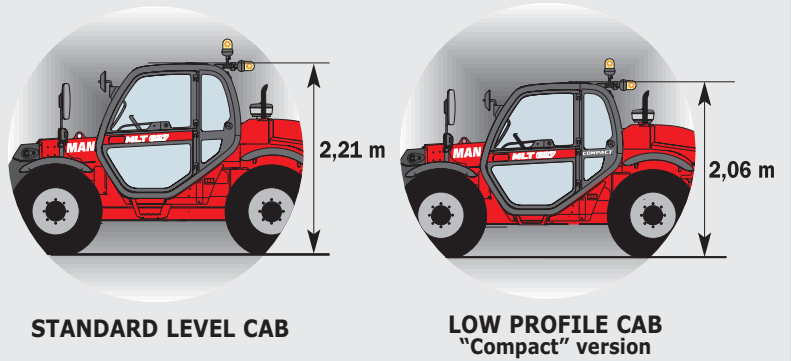

Reach at maximum height : 0,90 m

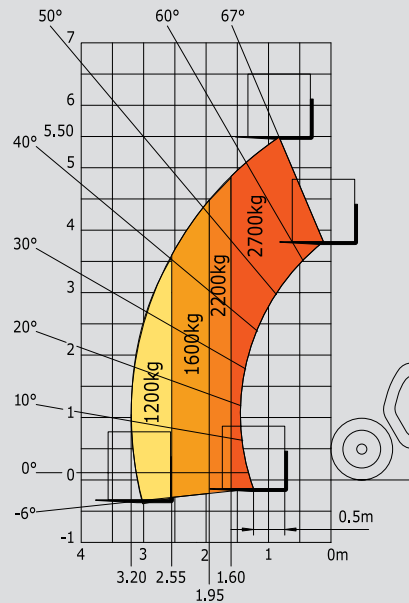

Under EN 1459 annexe B

MLT 627 T 20"	
A	1200
B	2520
C	1307
C1	1260
D	4687
D1	4640
D2	3925
E	5887
F	1600
G	400
I	860
J	866
K	1260
L	45
O	125
P2	41°
P3	39°
R	3385
S	7356
T	3520
U1	2060
U2	2320
V	4770
V1	1250
V2	3589
W	2007
Y	11,8°
Z	142,3°

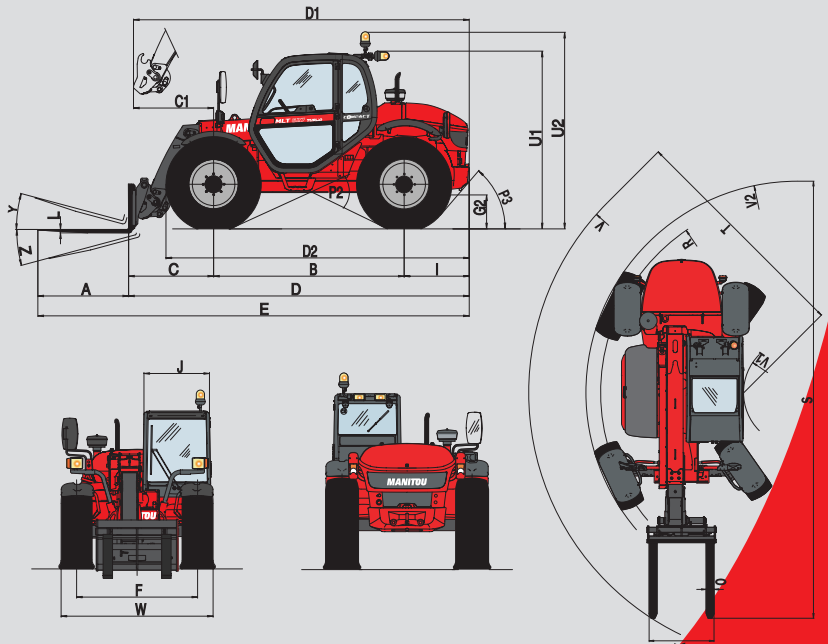

This publication in no way constitutes an offer and the company reserves the right to alter specification without prior notice.
The MANITOU models presented in this brochure can be supplied complete with optional equipment attachments.

